



Burner Systems:

- G4-12(P)
- G4-16/19(P)
- G4-18/20(P)
- G4-24(P)
- G4-30(P)
- G4-36(P)
- G4-42(P)
- G4-48(P)
- G4-60(P)



For use w/ propane or natural gas

Listed to:
Decorative Log Sets for Installation
in Wood-Burning Fireplaces
RGA2-72

(12" - 30" models)

**FOR INSTALLATION IN
SOLID-FUEL BURNING
FIREPLACES***

G4 VENTED GAS LOG SETS (MANUALLY LIGHTED)

WARNING: If the information in this manual is not followed exactly, a fire or explosion may result, causing property damage, personal injury, or loss of life.

- Do not store or use gasoline or other flammable vapors and liquids in the vicinity of this or any other appliance.

- WHAT TO DO IF YOU SMELL GAS:

- Do not try to light any appliance.
- Do not touch any electrical switch; do not use any phone in your building.
- Immediately call your gas supplier from a neighbor's phone. Follow the gas supplier's instructions.
- If you cannot reach the gas supplier, call the fire department.
- Open a window.

***Installation and service must be performed by a qualified installer, service agency, or the gas supplier.**

This appliance is only for use with the type of gas indicated on the rating plate.

IMPORTANT: READ THESE INSTRUCTIONS CAREFULLY BEFORE STARTING INSTALLATION OF THE UNIT.

The gas log set is to be installed only in a solid-fuel burning fireplace with a working flue and constructed of noncombustible material. The installation, and the provisions for combustion and ventilation air must conform to the *National Fuel Gas Code, ANSI Z223.1/ NFPA 54*, or the *Natural Gas and Propane Installation Code, CSAB149.1*, and applicable local building codes.

A damper clamp is included to maintain the minimum permanent vent opening and to prevent full closure of the damper blade. **The chimney damper MUST be fully opened when burning the unit. The unit is designed to burn with yellow flames; thus adequate ventilation is absolutely necessary.**

To comply with certification, listings, and building code acceptances, and for safe operation and proper performance of this gas log set, you must use **ONLY** Peterson Real Fyre parts, decorative media, and accessories. Use of any other controls, parts, or accessories not designed for use with Real Fyre gas log sets is prohibited. This will void all warranties, certifications, listings, and building code approvals, and may cause property damage, personal injury, or loss of life. Peterson will not be liable for any damages caused by this misuse.

***Note:** Solid-fuels shall not be burned in a fireplace where a decorative appliance is installed.



We recommend that our gas hearth products be installed and serviced by professionals who are certified in the U.S. by the National Fireplace Institute® (NFI) as NFI Gas Specialists.

INSTALLER:
Leave this manual with the appliance.
CONSUMER:
Retain this manual for future reference.



TWINING CONSULTING
Listing No. 1188

TABLE OF CONTENTS

GETTING STARTED

IMPORTANT PRE-INSTALLATION AND FIREPLACE SAFETY INFORMATION.....	3
FIREPLACE OPERATING SAFETY INFORMATION.....	4
SPECIFICATIONS.....	5
<i>PRODUCT SPECIFICATIONS</i>	5
<i>SAFETY PILOT KITS</i>	6
<i>ASH LIP/RECESS REQUIREMENTS (if applicable)</i>	6
<i>GLASS DOOR REQUIREMENTS</i>	7
DAMPER CLAMP INSTRUCTIONS.....	8
<i>MINIMUM PERMANENT FREE OPENING IN CHIMNEY</i>	8
G4 BURNER REPLACEMENT PARTS LIST.....	9

INSTALLATION

INSTALLATION.....	10
<i>INSTALL VALVE AND PILOT KIT (L.P. Models Only)</i>	10
<i>INSTALL BURNER</i>	10
<i>PREPARE GRATE AND CENTER</i>	11
<i>LAVA GRANULES/COALS (optional)</i>	11
<i>SAND/VERMICULITE PLACEMENT</i>	12
<i>GLOWING EMBERS PLACEMENT</i>	12
<i>SCREEN AND EMBERS PLACEMENT</i>	13
<i>GRATE PLACEMENT</i>	13
<i>LOG SET PLACEMENT</i>	14

USE, CARE, & SERVICE

LIGHTING INSTRUCTIONS.....	15
<i>FOR YOUR SAFETY, READ BEFORE LIGHTING</i>	15
<i>TO SHUT OFF GAS TO THE APPLIANCE</i>	15
NOTES PAGE.....	16
CLEANING AND SERVICING.....	17
FLAME DESCRIPTION.....	17
TROUBLESHOOTING.....	18
WARRANTY.....	20

IMPORTANT PRE-INSTALLATION AND FIREPLACE SAFETY INFORMATION

CAUTION: Installation and repair must be done by an NFI Certified or other qualified professional installer.

Installer: Carefully read these instructions before installing this gas burner system. Be sure you understand all safety precautions and warnings contained in this manual.

- A. **BE CAREFUL:** If not installed, serviced, and used correctly per these instructions, this product can cause serious personal injury, property damage, or loss of life.
- B. **A shut-off valve (not included) in the gas supply line is required.** It must be installed upstream of the unit and must be easily accessible. The shut-off valve cannot be located in the fireplace firebox. Refer to the NFPA 54 guidelines for further details.
- C. A sediment trap in the gas supply line is recommended where applicable. It should be installed downstream of the shut-off valve as close to the unit as possible. Refer to the NFPA 54 guidelines for further details.
- D. **WARNING:** When installing in a solid-fuel-burning fireplace, **the chimney flue, damper, and firebox must be thoroughly CLEANED** of soot, creosote, ashes, and loose paint, and must be inspected by a qualified chimney cleaner. Some older fireplaces may need repair prior to installing this appliance.
- E. The fireplace floor must be level and smooth.
- F. This appliance is only for use with the type of gas indicated on the rating plate.
CHECK GAS TYPE (natural or L.P.): The gas supply must be the same as stated on your burner system rating plate. If gas supply is different, **DO NOT INSTALL**. Contact your dealer for immediate assistance.
- G. **INSUFFICIENT GAS PRESSURE WILL KEEP THE UNIT FROM OPERATING PROPERLY. DO NOT USE IF GAS PRESSURE IS LOWER THAN THE MINIMUM REQUIREMENT.**
- H. The *minimum* inlet gas-supply pressure for purposes of input adjustment is **7"** water column (w.c.) on **natural gas** and **11"** w.c. on **L.P. gas**. Insufficient gas pressure will affect proper operation of the unit. Do not install this gas appliance if minimum pressure is not available. The *maximum* inlet gas-supply pressure is **10.5"** w.c. on natural gas and **13"** w.c. on L.P. gas. **The L.P. source must be regulated, located outside, and hard-lined in (rigid pipe must come into the fireplace). DO NOT connect this appliance to an unregulated L.P. gas tank/cylinder. DO NOT locate the tank/cylinder inside of the home. DO NOT run a rubber hose or flex connector into the fireplace. Failure to follow these requirements can cause an explosion, property damage, personal injury, or loss of life.**
- I. **The gas piping system must be sized to provide minimum inlet pressure at the maximum flow rate (BTU/hr).** Undue pressure loss will occur if the pipe is too small, or the run is too long. Gas supply pipe must be 1/2" minimum interior diameter. If the gas line is longer than 20', a larger diameter line may be necessary. Refer to the NFPA 54 guidelines for further details.
- J. Input ratings shown in BTU per hour are for elevations up to 2,000 ft. For elevations above 2,000 ft., refer to the National Fuel Gas Code or contact manufacturer before installing this product.
- K. This gas appliance and its appliance main gas valve must be disconnected from the gas supply piping system during any pressure testing of that system at test pressures in excess of 1/2 psi (3.5 kPa).
- L. This gas appliance must be isolated from the gas supply piping system by closing the gas supply shut-off valve during any pressure testing of the gas supply piping system at test pressures equal to or less than 1/2 psi (3.5 kPa).
- M. **To install the gas appliance in your fireplace, the fireplace MUST meet the minimum size requirements (see product specifications table in SPECIFICATIONS section).**
- N. This appliance may be installed in an aftermarket, permanently located, manufactured (mobile) home, where not prohibited by local codes. Installation of appliances designed for manufactured home (U.S. only) or mobile home installation must conform with the *Standard Mobile Housing, CAN/CSA Z240 MH*, in Canada, or with the *Manufactured Home Construction and Safety Standard, Title 24 CFR, Part 3280*, in the United States, or when such a standard is not applicable, *Manufactured Home Installations Standard ANSI/NCSCS A225.1/NFPA 501A*.
- O. **DO NOT install this burner system in a fireplace with an ash lip or recess greater than 3/4".**
- P. If this burner system is installed in a fireplace with **glass doors**, and the doors have a frame that obstructs airflow to the fireplace floor, the frame **MUST** have slots (above the fireplace floor) that allow adequate ventilation. The opening (with doors fully open) **MUST** meet the minimum fireplace size front width and height requirements. The glass doors **MUST** be fully open when the burner is in operation. See the SPECIFICATIONS section for details.

FIREPLACE OPERATING SAFETY INFORMATION

- A. Adults **MUST** be present when this gas appliance is operating. This appliance **MUST NOT** be left burning when unattended or while anyone is sleeping.
- B. Keep the appliance area clear and free from combustible materials, gasoline, and other flammable vapors and liquids.
- C. DO NOT use this appliance if any part has been underwater. Immediately call a qualified service technician to inspect the appliance and to replace any part of the control system and any gas control that has been underwater. Attempted operation may result in fire or explosion resulting in property damage, personal injury or loss of life.
- D. **A fireplace screen must be in place when the appliance is operating.** Provisions for adequate combustion air must be maintained. Unless other provisions for combustion air are provided, the screen shall have an opening(s) for introduction of combustion air. Combustion air is adequate when all flames curl into the fireplace and away from the screen. **When a glass fireplace enclosure (door) is used, the glass doors MUST be fully open when the burner is in operation.**
- E. Do not remove the rating plates or the warning tags. These are an integral safety and identification component of this appliance.
- F. Be sure to read the CLEANING AND SERVICING and FLAME DESCRIPTION sections.

SPECIFICATIONS

Real Fyre gas burner systems must be installed only in a wood burning fireplace with the minimum firebox dimensions and venting requirements met (see following tables). This appliance is designed to burn with yellow flames; adequate ventilation is absolutely necessary.

PRODUCT SPECIFICATIONS

Model	BTU Rating	
	Nat. Gas	L.P. Gas
G4-12	25k	25k
G4-16/19	39k	39k
G4-18/20	75k	50k
G4-24	90k	65k
G4-30	90k	65k
[G4-36]	120k	90k
[G4-42]	130k	110k
[G4-48]	145k	115k
[G4-60]	150k	120k

Table 1 - Product BTUs

Model (MATCH-LIT) (NAT. GAS ONLY)	Minimum Fireplace Size			
	Width *		Depth ‡	Height
	Front	Rear †		
G4-12	16"	12"	11"	15"
G4-16/19 (16" log set)	19"	16"	11"	17"
G4-16/19 (19" log set)	22"	17"	11"	17"
G4-18/20	24"	18"	13" ♦	17"
G4-24	28"	23"	13" ♦	17"
G4-30	34"	27"	14" ♦	17"
[G4-36]	40"	34"	15"	17"
[G4-42]	46"	40"	20"	17"
[G4-48]	53"	45"	20"	17"
[G4-60]	64"	56"	20"	17"

Table 2 - Minimum Fireplace Size: Match-lit (burner only)

Model (WITH SAFETY PILOT KIT) (NAT. OR L.P. GAS) ▲	Minimum Fireplace Size			
	Width *		Depth ‡	Height
	Front	Rear †		
G4-12	21"	19"	11"	15"
G4-16/19 (16" log set)	26"	22"	11"	17"
G4-16/19 (19" log set)	26"	22"	11"	17"
G4-18/20	29"	25"	13" ♦	17"
G4-24	34"	29"	13" ♦	17"
G4-30	39"	34"	14" ♦	17"
[G4-36]	46"	39"	15"	17"
[G4-42]	51"	45"	20"	17"
[G4-48]	58"	52"	20"	17"
[G4-60]	69"	63"	20"	17"

Table 3 - Minimum Fireplace Size: Burner with safety pilot kit

Important Information Regarding Dimensions

* These required widths allow for centering of the unit.

† Rear width is at corresponding depth.

‡ If an ash lip exists, the depth requirement begins inside of the lip (see FIREPLACE REQUIREMENTS section on following page).

♦ Add 1" to depth when using heavy duty grate.

[] Bracketed models indicate non-listed models.

▲ For Nat. gas models, a safety pilot kit is optional. For L.P. models, a kit is required (use the included SPK-26P, or an optional kit). See SAFETY PILOT KITS section on following page for more details.

Note: Table 3 dimensions apply for all safety pilot kits.

SAFETY PILOT KITS

THIS BURNER COMES WITHOUT A VALVE INSTALLED.

NATURAL GAS MODELS CAN BE INSTALLED TO AND OPERATED BY YOUR FIREPLACE VALVE, OR ONE OF THE OPTIONAL R.H. PETERSON SAFETY PILOT KITS (SEE BELOW).

FOR PROPANE MODELS, YOUR BURNER MUST BE INSTALLED WITH THE INCLUDED SAFETY PILOT KIT (SPK-26P), OR ONE OF THE OPTIONAL R.H. PETERSON SAFETY PILOT KITS (SEE BELOW).

Contact your local Real Fyre dealer when ordering.

To comply with certification, listings, and building code acceptances, and for safe operation and proper performance of this burner system, you must use ONLY R.H. Peterson parts and accessories.

Description	Model
Low Profile, Safety Pilot Kit	SPK-26(P)
High Capacity, Automatic Pilot Kit with basic transmitter & receiver	APK-10(P)
Automatic Pilot Kit with basic transmitter & receiver	APK-11(P)
Variable, Automatic Pilot Kit with basic transmitter & receiver	APK-15(P)
Low Profile, Variable, Automatic Pilot Kit with basic transmitter & receiver	APK-17(P)
Electronic Pilot Kit with on/off basic transmitter & receiver	EPK-2(P)
110 Volt Powered Electronic, non-standing pilot system	EPK-2M-AD(/LP)
110 Volt Powered Electronic, non-standing pilot system with variable flame height control	EPK-2V(P)-TR
High Capacity, 110 Volt Powered Electronic, non-standing pilot system w/variable flame height control	EPK-3V(P)-TR
Electronic Pilot System with hot surface ignition and smart valve	EPK-05(P)
Manual On/Off Valve with extension and knob handle or rod handle	AV-17 / AV-18

Table 4 - Optional Safety Pilot Kits

ASH LIP/RECESS REQUIREMENTS (if applicable)

- DO NOT install this burner system in a fireplace with an ash lip or recess greater than 3/4".
- The depth (as indicated in the chart on the previous page) begins inside of the lip.

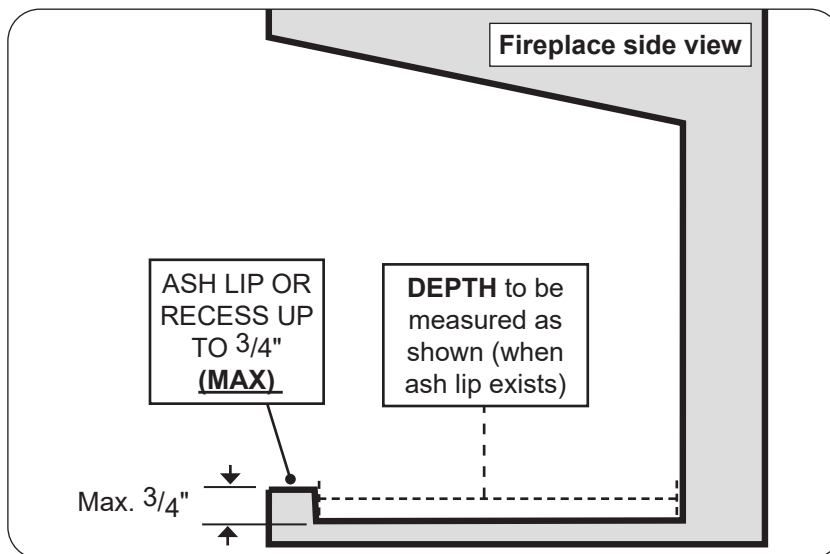

Fig. 6-1 Ash lip/recess detail

GLASS DOOR REQUIREMENTS

If this burner system is installed in a fireplace with glass doors, and the doors have a frame that OBSTRUCTS AIRFLOW to the fireplace floor, the frame MUST have slots (above the fireplace floor) that allow adequate ventilation. See Fig. 7-1.

Important: The opening (with doors fully open) MUST meet the minimum fireplace size front width and height requirements. See Tables 2 and 3 under PRODUCT SPECIFICATIONS and Fig. 7-1.

Important: The glass doors MUST be fully open when the burner is in operation.

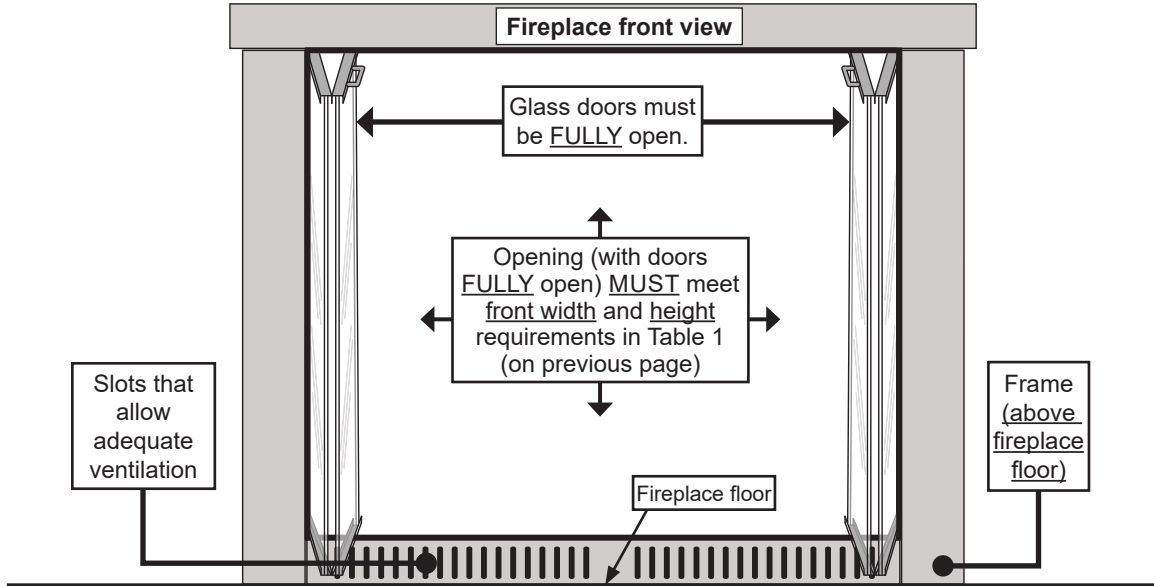

Fig. 7-1 Correct glass-doors frame setup, ventilation, and use (if applicable)

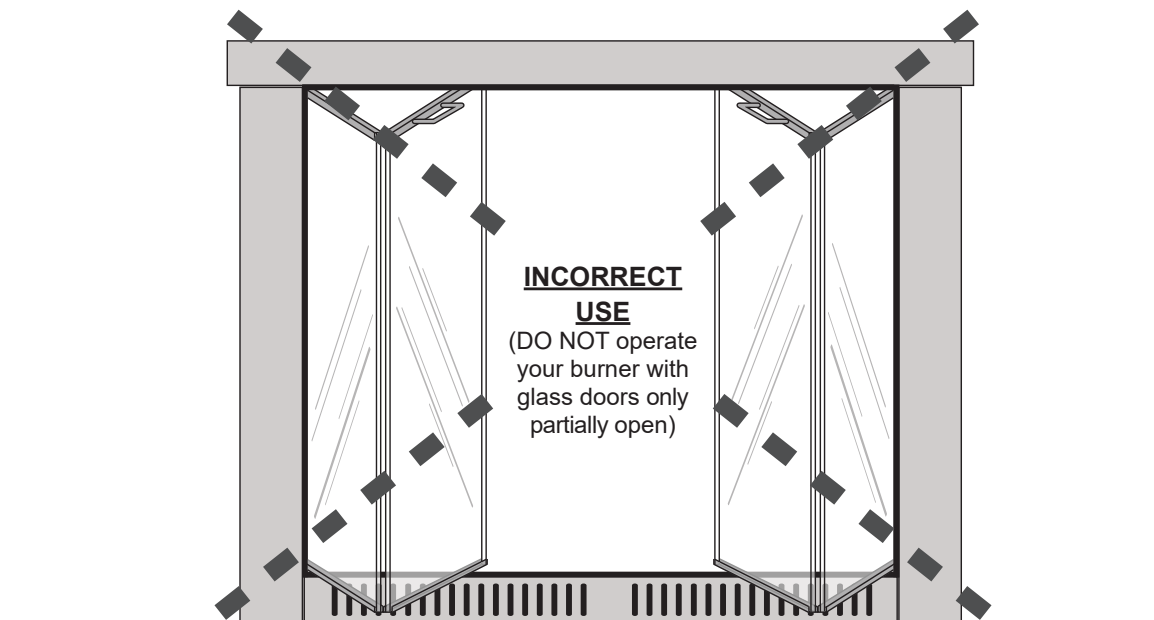

Fig. 7-2 Incorrect glass-doors frame setup, ventilation, and use (if applicable)

DAMPER CLAMP INSTRUCTIONS

CAUTION: The chimney damper **MUST** be fixed in a manner that will maintain the minimum permanent vent opening at all times. See below.

The chimney damper **MUST** be fully open when burning the unit.

The damper clamp with hex bolt is provided as a means to prevent full closure of the damper blade. It must be permanently installed.

Attach the damper clamp to the damper blade with pliers or a small adjustable wrench. See Fig. 8-1 and Fig. 8-2.

Note: Should the clamp not fit or fail to provide the permanent vent opening listed in the Table below, have a permanent stop installed, remove the damper blade, or have the damper cut to provide the minimum permanent free opening required.

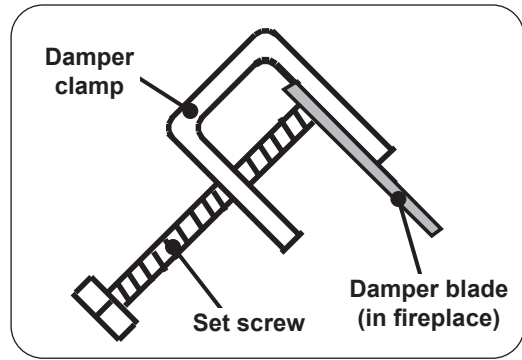

Fig. 8-1 Damper clamp detail

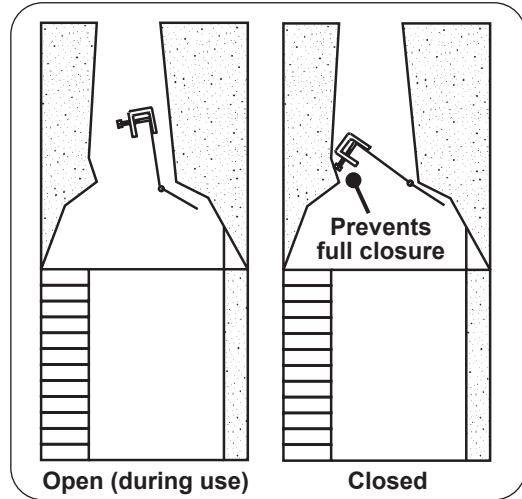

Fig. 8-2 Damper open / closed

MINIMUM PERMANENT FREE OPENING IN CHIMNEY

Note: The minimum chimney height from hearth to top of chimney is 15'.

Chimney height	For factory-built fireplaces									
	12"	16/19"	18/20"	24"	30"	36"	42"	48"	60"	
15'	11 sq. in.	18 sq. in.	36 sq. in.	46 sq. in.	46 sq. in.	62 sq. in.	66 sq. in.	74 sq. in.	76 sq. in.	
20'	10 sq. in.	15 sq. in.	29 sq. in.	38 sq. in.	38 sq. in.	56 sq. in.	58 sq. in.	66 sq. in.	68 sq. in.	
30'	8 sq. in.	12 sq. in.	23 sq. in.	29 sq. in.	29 sq. in.	45 sq. in.	49 sq. in.	57 sq. in.	59 sq. in.	
Chimney height	For masonry-built fireplaces									
	15'	17 sq. in.	27 sq. in.	46 sq. in.	55 sq. in.	55 sq. in.	70 sq. in.	76 sq. in.	84 sq. in.	86 sq. in.
	20'	16 sq. in.	24 sq. in.	42 sq. in.	50 sq. in.	50 sq. in.	63 sq. in.	68 sq. in.	76 sq. in.	78 sq. in.
30'	15 sq. in.	22 sq. in.	38 sq. in.	45 sq. in.	45 sq. in.	57 sq. in.	59 sq. in.	67 sq. in.	69 sq. in.	

Table 5 - Minimum permanent free opening (at fireplace chimney/damper)

THESE ARE MINIMUM DAMPER OPENING SPECIFICATIONS.

THE DAMPER MUST BE FULLY OPEN WHEN OPERATING THIS GAS APPLIANCE TO ACHIEVE THE BEST VENTILATION POSSIBLE.

G4 BURNER REPLACEMENT PARTS LIST



24" burner model shown

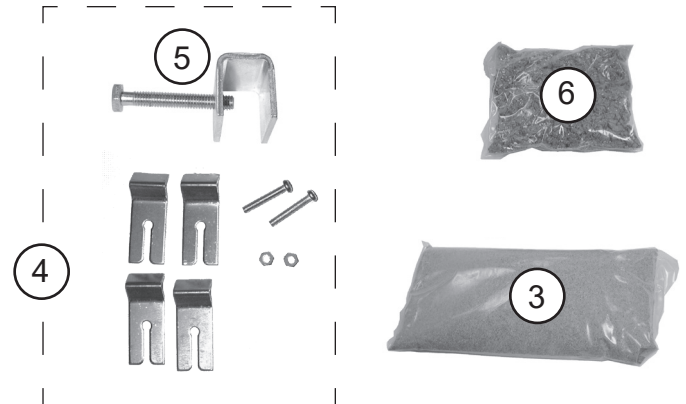
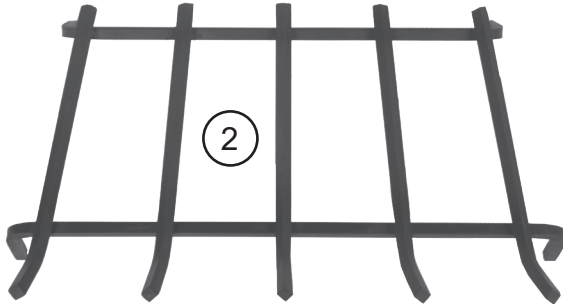
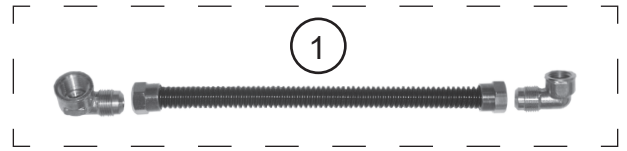

Note: Photos not to scale

Replacement parts can be ordered from your local Real Fyre dealer.

The log set is purchased and packaged separately; contact your local Real Fyre dealer when ordering. Refer to the instructions included with the log set.

For propane models, refer to separate PARTS LIST supplied with the pilot kit.

Item	Description	12" model		16/19" model		18/20" model		24" model		30" model	
		Part No.	Qty.	Part No.	Qty.	Part No.	Qty.	Part No.	Qty.	Part No.	Qty.
1.	Flex connector (w/ adapters), 1/2" O.D. x 12"	CK-5	1	CK-5	1	CK-5	1	CK-5	1	CK-5	1
2.	Grate	SD-12	1	SD-16/19	1	SD-18	1	SD-24	1	SD-30	1
3.	Sand (natural gas)	CS-6	1	CS-8	1	CS-8	1	CS-10	1	CS-12	1
or	Vermiculite (propane gas)	LF-15-3.5	1	LF-15-3.5	1	LF-15-3.5	1	LF-15-7	1	LF-15	1
4.	Hardware kit (damper clamp, stabilizer clips w/ screws and nuts)	HK-1	1	HK-1	1	HK-1	1	HK-1	1	HK-1	1
5.	Damper clamp (only)	DC-1	1	DC-1	1	DC-1	1	DC-1	1	DC-1	1
6.	Glowing embers	EM-1	1	EM-1	1	EM-1	1	EM-1	1	EM-1	1

Item	Description	36" model		42" model		48" model		60" model	
		Part No.	Qty.	Part No.	Qty.	Part No.	Qty.	Part No.	Qty.
1.	Flex connector (w/ adapters), 1/2" O.D. x 12"	CK-5	1	CK-5	1	CK-5	1	CK-5	1
2.	Grate	SX-36	1	SX-42	1	SX-48	1	SX-60	1
3.	Sand (natural gas)	CS-15	1	CS-10	2	CS-15	1	CS-15	2
or	Vermiculite (propane gas)	LF-15-7	2	LF-15	1	CS-10	1	LF-15	2
				LF-15-7	1	LF-15	2	LF-15-7	1
4.	Hardware kit (damper clamp, stabilizer clips w/ screws and nuts)	HK-1	1	HK-1	1	HK-1	1	HK-1	1
5.	Damper clamp (only)	DC-1	1	DC-1	1	DC-1	1	DC-1	1
6.	Glowing embers	EM-1	2	EM-1	2	EM-1	3	EM-1	5

INSTALLATION

The Real Fyre burner system must be installed by a qualified professional service technician. Instructions must be followed carefully to ensure proper performance and full benefit from the burner system. **Check to be sure the burner system is designed and labeled for the type of gas (natural or propane gas) supplied to fireplace. Fireplace floor must be level, clean, and smooth (see FIREPLACE SAFETY INFORMATION section).**

WARNING: Failure to position the parts in accordance with these diagrams or failure to use only parts specifically approved with this appliance may result in property damage or personal injury.

REFER TO THE PARTS LIST WHEN FOLLOWING INSTALLATION INSTRUCTIONS.

The burner pan is supplied with an air mixer for propane gas or a fuel injector for natural gas. **The air mixer / fuel injector must be used in ALL installations.** The air mixer / fuel injector has a precisely sized orifice to ensure only the proper amount of gas enters the burner. This allows maximum performance and gas conservation.

INSTALL VALVE AND PILOT KIT (L.P. Models Only)

For L.P. models, the valve and pilot assembly must first be installed. Carefully follow the instructions supplied with the pilot kit for specific setup. Then return to the following PREPARE GRATE AND CENTER section to continue with installation.

24" burner model shown here.

INSTALL BURNER

1. MAKE SURE FIREPLACE GAS SUPPLY IS TURNED OFF.
2. Locate the gas-supply stub inside the fireplace and remove the cap, if attached (reference Fig. 10-1).

CAUTION: When removing the cap, make sure the stub does not turn, loosening the connection inside the wall.

3. Remove the small adapter connected to the flex connector (included). Attach the adapter to the fuel injector / air mixer found on the side of the burner pan using a pipe compound resistant to all gasses. Tighten securely. Then attach the flex connector to the adapter. Tighten securely (See Fig. 10-1).

Important: DO NOT remove the fuel injector / air mixer.

4. Place the burner system in the fireplace. Center the burner from left to right in the fireplace. See Fig. 10-2.
5. **Be sure gas to the fireplace is off.** Remove the large adapter connected to the other end of the flex connector. Attach the adapter to the gas-supply stub using a pipe compound resistant to all gasses. Tighten securely. Then attach the flex connector to the adapter. Tighten securely. See Fig. 10-1. Ensure the pan rests level on the fireplace floor after connection. Adjust the pan if necessary.
6. **LEAKTEST:** Follow the appropriate LIGHTING INSTRUCTIONS for your model to ignite the burner. Test at all connections for leaks using the appropriate soapy water solution. See Fig. 10-3. If bubbles appear, a leak is present. Turn off the gas and tighten at all connections. Repeat until no leaks are present. If a leak persists, turn off the gas supply and contact the local gas company or dealer. NEVER USE A FLAME TO CHECK FOR LEAKS.

Turn off the gas supply and allow unit to completely cool prior to proceeding.

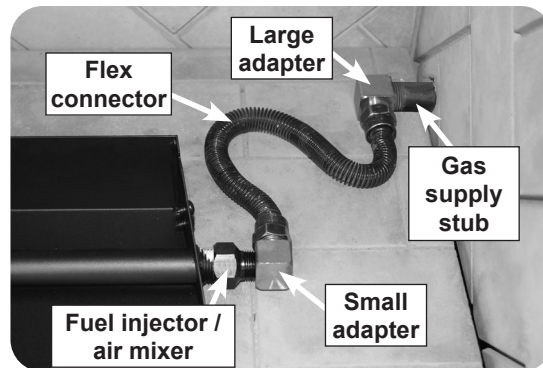

Fig. 10-1 Connect gas supply



Fig. 10-2 Center burner in fireplace

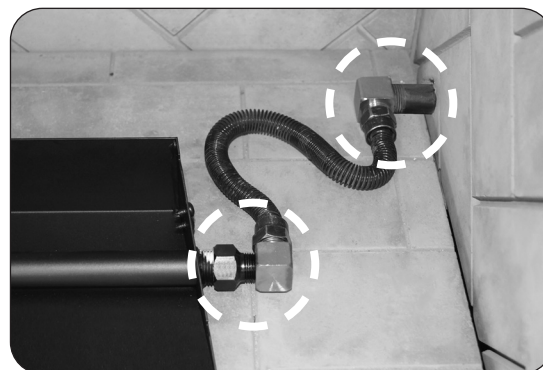

Fig. 10-3 Perform leak test

Installation continued on next page

PREPARE GRATE AND CENTER

1. Locate the grate (outside of the fireplace) and attach the stabilizer clips to the 2 outer bars of the grate using the provided screws and nuts (see Fig. 11-1 and Fig. 11-3).

The stabilizer clips should be positioned toward the middle of the outer bars and oriented as shown in Fig. 11-1. Tighten the clips in place.

2. Position the grate over the burner pan (in fireplace) so the stabilizer clips fit over the back edge of the pan to lock it in position. Ensure the assembly is centered from left to right. See Fig. 11-2 and Fig. 11-3.

Then remove the grate for future media placement.

LAVA GRANULES/COALS (optional)

Optional lava granules and lava coals are available for decorative purposes. Contact your dealer for ordering information.

If purchased, follow the steps below.

1. Spread the lava granules on the floor of the fireplace, around the front and sides of the burner system (see Fig. 11-4).
2. Repeat this process for the lava coals (on top of the already placed lava granules).

Note: DO NOT place any lava media on the burner system, or behind it. If a pilot kit has been installed, DO NOT place any lava media on or within the heat shield, or under a knob if one exists at the front of the valve.

Installation continued on next page

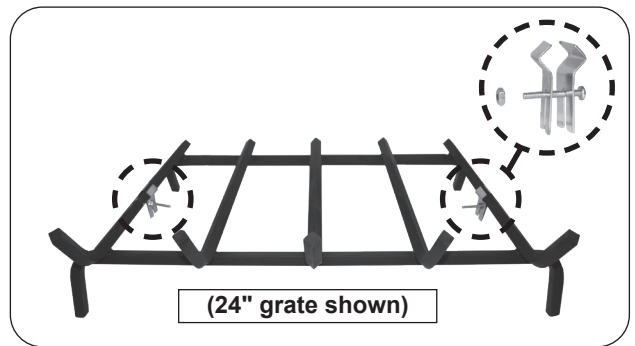

Fig. 11-1 Attach stabilizer clips to grate

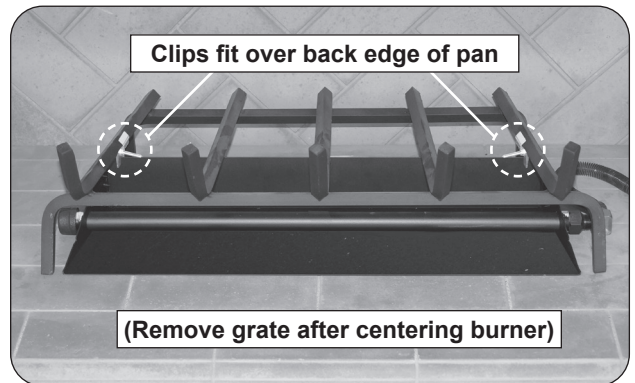

Fig. 11-2 Position grate

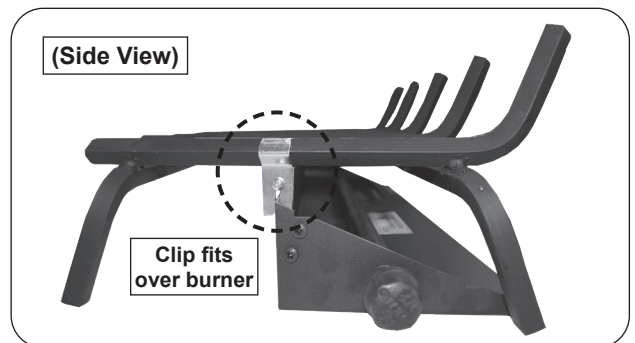

Fig. 11-3 Grate placement detail

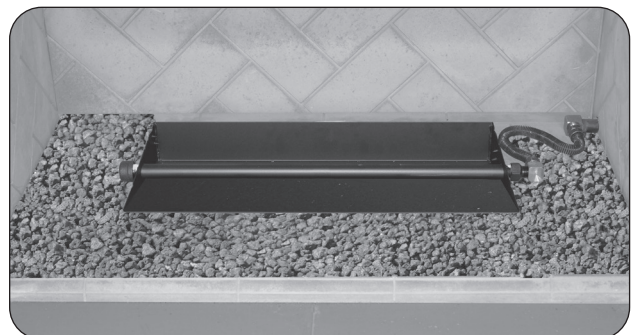

Fig. 11-4 Place lava media (if option purchased)

SAND/VERMICULITE PLACEMENT

The sand/vermiculite supplied with the unit is specially selected for use with either natural or propane gas. It maximizes flame distribution and provides a cleaner burning flame.

CAUTION: Use only sand for natural gas burners and vermiculite for propane gas burners.

1. Fill the burner pan completely with the sand/vermiculite (see Fig. 12-1).
 - **If a pilot kit has been installed, avoid spilling the sand/vermiculite on the pilot assembly. DO NOT place sand/vermiculite on any other parts of the burner, valve, or heat shield.**
 - Store excess sand/vermiculite in a safe location.
2. **Slope the sand/vermiculite at the same angle as the burner pan.** This is important to ensure quiet lighting and even flame distribution. See Fig. 12-2.

GLOWING EMBERS PLACEMENT

Sprinkle the glowing embers lightly and evenly over the entire surface of the sand/vermiculite as shown in Fig. 12-3. **Break up any clumps that may have developed during shipment. Store unused embers for later use/replacement.**

**IF A PILOT KIT HAS BEEN INSTALLED:
KEEP LAVA GRANULES/COALS, SAND/
VERMICULITE, EMBERS, AND ALL FOREIGN
OBJECTS AWAY FROM THE PILOT
ASSEMBLY, VALVE ASSEMBLY, AND HEAT
SHIELD(S) DURING MEDIA PLACEMENT
AND AT ALL TIMES.**

Installation continued on next page



Fig. 12-1 Place sand/vermiculite

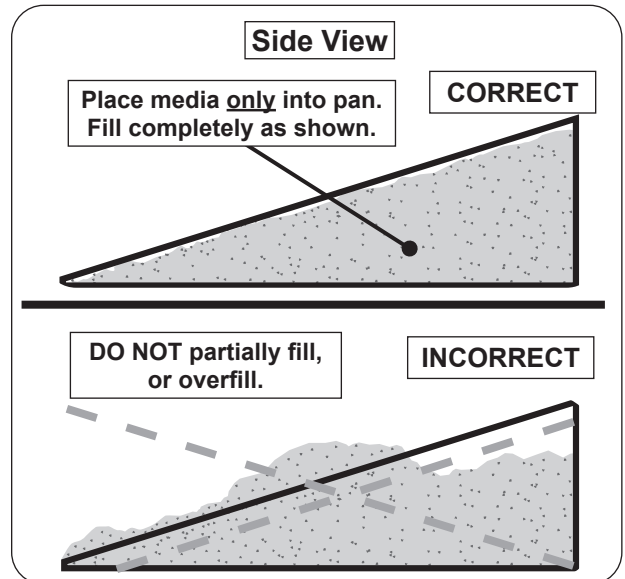

Fig. 12-2 Correct/Incorrect media placement (sand or vermiculite)

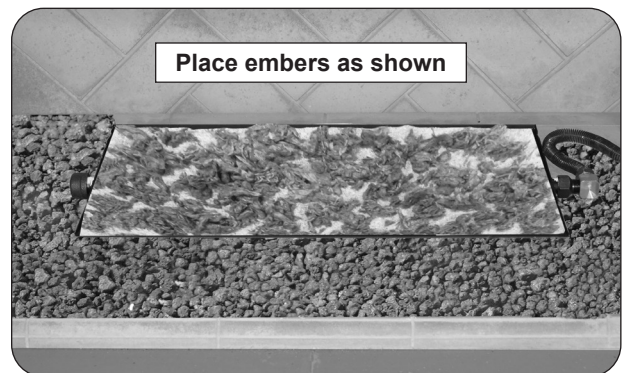

Fig. 12-3 Place glowing embers

SCREEN AND EMBERS PLACEMENT (Charred Log Sets Only)

Charred log sets include an ember screen and additional embers that are to be placed at this stage.

1. Attach the ember screen to the burner by slipping it onto the back edge (center left to right) with the perforated section facing towards the back fireplace wall (Fig. 13-1).
2. Cover the surface of the ember screen with the additional glowing embers as shown in Fig. 13-2.

Place the glowing embers evenly over the entire surface of the screen. **Break up any clumps that may have developed during shipment. Store unused embers for later use/replacement.**

GRATE PLACEMENT

Place the grate so that the stabilizer clips fit over the back edge of the pan, locking it in position (see Fig. 13-3).

Installation continued on next page

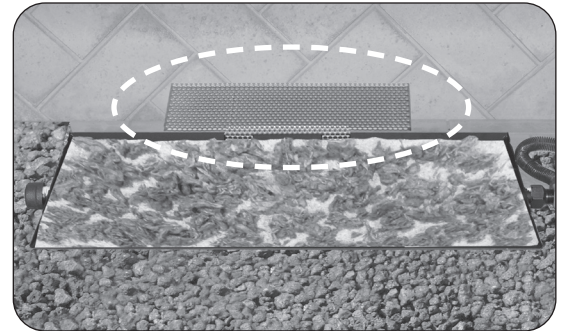

Fig. 13-1 Attach screen (if applicable)

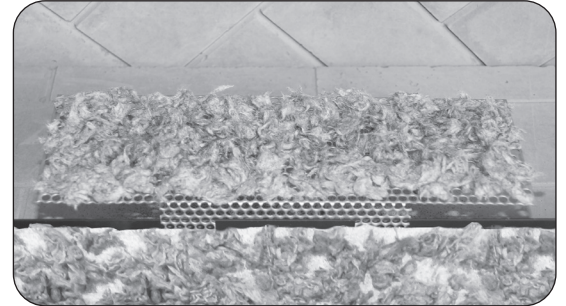

Fig. 13-2 Cover screen with embers

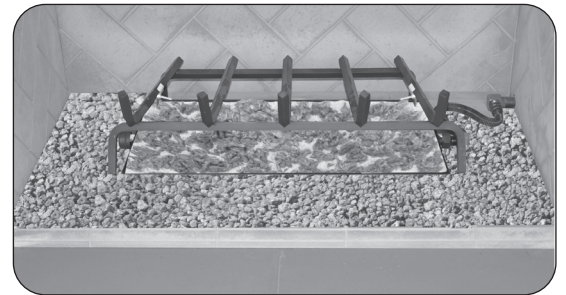

Fig. 13-3 Place grate

INSTALLATION (cont.)

LOG SET PLACEMENT

- Follow the instructions included with the log set for step by step log placement.
- Read all safety warnings and important information in the instructions supplied with the log set to ensure proper placement.
- **DO NOT** add any additional embers to this log set. Any additional embers will cause unsafe operation.
- Some logs are heavy and require two or more people to handle. Exercise extreme care during placement.
- **IF A CHARRED LOG SET IS PURCHASED:**
Refer back to the SCREEN AND EMBERS PLACEMENT section for details on placing the ember screen and additional embers provided with the charred log set.

Below are examples of available log sets for this burner system:



Charred Oak (CHD-24)

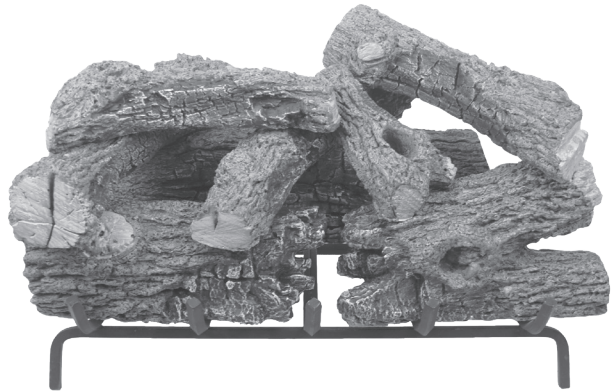

Charred Royal English Oak (CHB-24)



Golden Oak Designer Plus (RDP-24)



Golden Oak (R-24)

Important: Adequate ventilation is absolutely necessary! Provided significant, noticeable sooting **does not** occur, some flexibility is possible in log placement to suit your individual preference. If you experience a continued accumulation of black carbon (soot) on your logs it is an indication of incomplete combustion and you must move the affected log(s) so as to minimize the flame contact on the affected log(s). Read the instructions supplied with the log set completely and carefully.

CAUTION: BURN HAZARD! Logs will remain hot for some time after use. Use heat-resistant gloves or allow logs adequate time to cool before handling.

LIGHTING INSTRUCTIONS

FOR YOUR SAFETY, READ BEFORE LIGHTING

WARNING: If you do not follow these instructions exactly, a fire or explosion may result causing property damage, personal injury or loss of life.
Be cautious around all hot surfaces.

- A. **BEFORE LIGHTING**, smell all around the unit area for gas. Be sure to smell next to the floor, because some gas is heavier than air and will settle on the floor.
- B. **WHAT TO DO IF YOU SMELL GAS**
 1. Shut off the gas to the appliance.
 2. Extinguish any open flame.
 3. If odor continues, immediately call your gas supplier or the fire department.
- C. Use only a proper key to turn the gas line valve. Never use tools. If the valve will not turn, **DO NOT** try to repair it. Call a qualified professional service technician. Force or attempted repair may result in fire or explosion.

If your burner is operated by a pilot kit, carefully follow the lighting instructions supplied with your pilot kit.

1. **STOP!** Read the safety information above.
2. Ensure the key valve is completely in the **OFF** position before beginning lighting sequence.
3. Light a long-stem match or a long-necked butane lighter, and place the flame against the surface of the decorative media near the burner (Fig. 15-1).
4. **Once the flame is in position**, slowly turn the key valve counter-clockwise toward the **ON** position until it no longer rotates (see Fig. 15-2). Your burner should light.

WARNING: If the burner does not light within (5) seconds of turning on the key valve, immediately turn the key valve clockwise toward the **OFF** position until it no longer rotates.

Wait approximately five (5) minutes to clear out any gas, and repeat steps 3-4 above.

If your burner fails to light again, turn the key valve clockwise toward the **OFF** position until it no longer rotates and contact your dealer or gas supplier.

Note: The flame height can be adjusted via the key valve.

TO SHUT OFF GAS TO THE APPLIANCE

To extinguish your gas burner, turn the key valve clockwise toward the **OFF** position until it no longer rotates (see Fig. 15-2). Be sure the key valve is turned fully off to avoid any gas leakage.

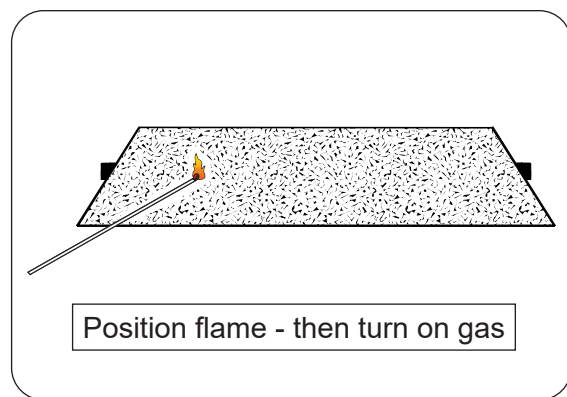

Fig. 15-1

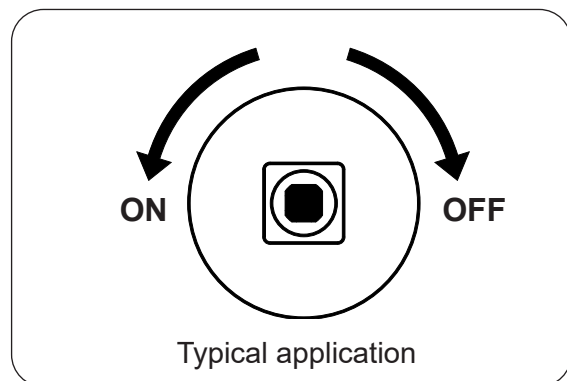

Fig. 15-2

Please use this page to record any information that you may want to have at hand.

CLEANING AND SERVICING

Note: Discoloration is common on the grate after burning.

Note: Servicing may be necessary to ensure proper operation and burn characteristics.

Always shut off the gas to the appliance while performing service work.

Allow the appliance to cool before servicing.

Installation, service, and repair must be done by an NFI Certified or other qualified professional service technician. The appliance should be examined before use, and must be inspected at least annually to prevent burner shutdown, sooting, odors, etc. It must be checked for clean burning operation with the correct tools to service this unit. More frequent servicing may be required. It is imperative that all components and compartments, burner(s), and circulating air passageways of the appliance be kept clean and free of all obstructions (as applicable).

In addition, a periodic examination and cleaning of the fireplace venting system should be conducted by a qualified professional service technician.

Any safety screen or guard removed for servicing must be replaced prior to operating this appliance.

Verify proper operation after servicing.

If, after a period of use, the flames start to exhibit unusual shapes and behavior, or the burners fail to ignite smoothly, the burner may require cleaning or servicing. If this happens, it is recommended to contact the nearest dealer to get the appliance serviced.

DO NOT remove the rating plates or the warning tags. These are an integral safety and identification component of this appliance.

We recommend following these instructions at the beginning of each fireplace season and as needed throughout the year, depending on your usage pattern and the environmental conditions in your home. More frequent cleaning and maintenance may be necessary when burning propane gas than with natural gas.

FLAME DESCRIPTION

Observe the flames. The main burner flames should be blue at the base and a combination of blue/yellow at the body and at the tips. They should be approximately 5-8" above the logs, with the center flame being the tallest. The ember flames should be 1/4" above the embers (See 17-1 for example.)



Fig. 17-1 Flame appearance

TROUBLESHOOTING

POSSIBLE CAUSE	SOLUTIONS
1 BURNER SHUTTING DOWN DURING OPERATION	
A. Insufficient or excessive gas pressure	A1. Check gas pressure (Read D.- F. of IMPORTANT PRE-INSTALLATION AND FIREPLACE SAFETY INFORMATION section, & check with local gas company). A2. Other gas appliances may be on the same gas line, dropping gas pressure to the burner. Check pressures with everything operating to ensure adequate pressure.
B. Fireplace too small for unit	B. Ensure minimum requirements are met (see SPECIFICATIONS section).
C. Blockages on burner	C. Vacuum any lava granules or material that may have fallen onto burner port area.
2 LOW FLAME HEIGHT	
A. Gas pressure	A. Check gas pressure (see Section 1, A1 of this table).
B. Key valve not fully open	B. Open key valve fully.
C. Blockage or kink in flex connector kit, plumbing, or burner orifice	C. Clean out blockage. If flex connector is kinked, replace it.
D. Incorrect media (sand or vermiculite) for gas type	D. Contact dealer for proper media (sand or vermiculite).
3 BURNER NOT BURNING EVENLY	
A. Burner ports clogged	A. Clean burner ports.
B. Media may be packed down too tightly	B. Loosen media around burner pipe by running a flathead screwdriver along both sides of the pipe. Even out media in burner pan.
4 ODORS	
A. Gas leak	A. Shut off gas, if possible. Follow instructions on front page. Have a qualified professional installer or the gas company correct all leaks.
B. New home, new carpet, or new paint	B. When these odors are drawn into the fireplace, this may cause objectionable odors. Thoroughly ventilate the area before restarting your burner system.
C. Damper not properly open, or closed	C. Ensure that damper is <u>fully</u> open.

5**SMOKING AND/OR SOOTING**

A. Poor draft or downdraft	A. Check for chimney blockage. Be sure chimney is at least 3' taller than anything within 10' of it in all directions. If not, consult a chimney sweep. A chimney cap or fan may help.
B. Damper not properly open, or closed	B. Ensure that damper is <u>fully</u> open.
C. Burner is positioned too close to the front of the firebox	C. Move burner system to the center of the firebox.
D. Improper media placement	D. See INSTALLATION section for proper media placement.
E. Air shutter(s) closed (if applicable)	E. Open air shutter(s) as needed.
F. Air shutter(s) blocked with debris (if applicable)	F. Vacuum debris away from air shutter(s).
G. Log placement	G. See solution in Section 1, B.
H. Using natural-gas burner on propane gas or propane gas on natural gas	H. If the gas listed on the nameplate does not match the gas you are burning, shut down the burner system immediately. Then call your dealer.
I. Adding any accessories to burner system	I. Shut down burner system and take off any accessories that do not belong with the system.

6**FLAME AT AIR MIX / ORIFICE (PROPANE MODELS)**

A. Burner ports clogged	A. Clean burner ports.
B. Gas pressure	B. Check gas pressure (see Section 1, A1 of this table).
C. Incorrect media for propane gas and/or media may be packed down too tightly	C. Ensure proper vermiculite media is used with propane gas. Loosen media around burner pipe by running a flathead screwdriver along both sides of the pipe. Even out media in burner pan.

WARRANTY

PETERSON VENTED DECORATIVE GAS APPLIANCE LIMITED WARRANTY

R.H. Peterson Co. ("RHP") warrants your Real Fyre® vented decorative gas appliance to be free from defects in material and workmanship.

RHP vented refractory gas logs are warranted for **as long as the original purchaser owns them (lifetime) when used indoors and for THREE (3) YEARS when used outdoors.**

RHP vented fiber-ceramic blended gas logs are warranted for **FIVE (5) YEARS when used indoors and for THREE (3) YEARS when used outdoors.**

RHP **indoor** vented gas log burners and stainless steel burners (excluding controls) are warranted for **TEN (10) YEARS.**

RHP **outdoor** vented stainless steel burners (excluding controls) are warranted for **FIVE (5) YEARS.**

The **SPK-26** is warranted for **THREE (3) YEARS** and **APK-17** (including -17 valve) is warranted for **TWO (2) YEARS.**

All other valves, pilots, and controls are warranted for **ONE (1) YEAR** (excluding batteries).

RHP glass, gems, and nuggets are warranted for **TEN (10) YEARS.**

A COPY OF YOUR SALES SLIP FOR PROOF OF PURCHASE IS REQUIRED

This warranty applies to the original residential purchaser for products which are installed in the United States or Canada and which are operated and maintained as intended for single family residential usage. This warranty is valid only with proof of purchase, commences on the date of purchase, and terminates (both as to original and any replacement products) on the anniversary date of the original purchase of the product per the above schedules.

This warranty covers defects in material and workmanship. This warranty **does not** cover parts which become defective as a result of negligence, misuse, use not in compliance with the Installation and Owner's Manual, accidental damage, improper handling, improper storage, improper installation, **lack of required routine maintenance** (as specified in the Installation and Owner's Manual), electrical damage, local gas impurities or failure to protect against combustible materials. Product must be installed (and gas must be connected) as specified in the Installation and Owner's Manual by a **qualified professional installer**. This warranty **does not** apply to rust, corrosion, oxidation, or discoloration unless the affected part becomes inoperable. RHP products including valves, pilots and controls, are designed and certified to be used as a system. Modifications to products which are not specifically authorized will void this warranty and could render the product to be unsafe. Burners, valves, parts, accessories, remotes, etc. used with this product must be RHP products or this warranty is void.

Warranted items will be repaired or replaced at RHP's sole discretion. This warranty **does not** cover labor or labor related charges, except as provided by separate specific written programs from RHP. All repair work must be performed by a qualified professional service person and requires prior approval of RHP.

RHP may require the defective product or part to be returned to the factory to determine the cause of failure. RHP will pay freight charges if the product or part is determined to be defective. This warranty does not cover breakage in shipment from our independent distributor to its customer if the damage is determined to have occurred during that shipment.

This warranty specifically excludes liability for **indirect, incidental**, or consequential damages. Some states and provinces do not allow the exclusion or limitation of incidental or consequential damages, so the above exclusion may not apply to you. This warranty gives you specified legal rights, and you may have other rights that vary from state to state or province.

For additional information regarding this warranty, or to place a warranty claim, contact the RHP dealer where the product was purchased.

When contacting your RHP dealer or the R.H. Peterson Co., please provide the following information:

- Your name, address, telephone number, e-mail
- Sales receipt showing where purchased and date purchased
- Model number, serial number of product, date code
- Relevant information: installer, additions, repairs, when defect was first noted

**TO REGISTER YOUR PRODUCT ONLINE GO TO: WWW.RHPETERSON.COM,
AND CLICK ON PRODUCT REGISTRATION. THANK YOU FOR YOUR PURCHASE.**