

# HI/LO Fyrestarter Bluetooth Control (H Models)

**INSTALLER:** Leave these instructions with consumer.  
**CONSUMER:** Retain for future reference.

## GETTING STARTED

### VERIFY COMPATIBILITY

This bluetooth control is offered with select AFD Fire Units, and is compatible with select electronic devices. See Table 1 and Table 2.

Product	Models
<b>Firetables</b>	215, 216, 580, 581, 586, 588, 589, 635, 640, 642, 645, 735, 736, 738, 744, 759, 782, 783, 784
<b>Firebowls</b>	430, 435, 731, 732, 733, 744, 751, 752, 759
<b>Firepits</b>	680, 681, 685, 686, 688, 689
<b>Lanterns</b>	715, 716

**Table 1 - Burner System Compatibility**

Electronic Device	Software Version	Models
Apple iPhone	iOS 10 & above	iPhone 5 & above
Apple iPad	2nd generation	iPad, iPad Mini, & iPad Pro
Android devices	Android 4.4 & above	All Android devices

**Table 2 - Electronic Device Compatibility**

### INSTALL FIRE UNIT

If not already done, follow the instruction manual provided with your unit for proper installation.

Then proceed to the following APP SETUP section.

Videos and additional information are available online to assist with app setup and app operation.

Visit [www.americanfyredesigns.com/fyrestarter/](http://www.americanfyredesigns.com/fyrestarter/) or simply scan the QR code on the right.

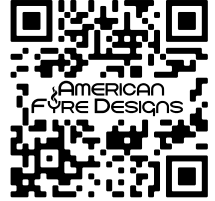

For videos on app setup & operation, visit [www.americanfyredesigns.com/fyrestarter](http://www.americanfyredesigns.com/fyrestarter) and locate the App Setup and App Operation videos.

## CREATE AN ACCOUNT

**Note:** This app setup process must be repeated for each device in the household that will be used for operation. Download the "RHP Connect" app from the Peterson website or by searching in your app store (see Fig. 3-1 for app logo). Then follow the prompts on your screen to create an account. See Fig. 3-2 through Fig. 3-4 for details.

- You will receive an e-mail with a confirmation code; please check junk/spam folders in case the e-mail gets blocked.
- For select devices, you can sign in using external platforms such as Google or Facebook.



**Fig. 3-1**  
Download RHP Connect

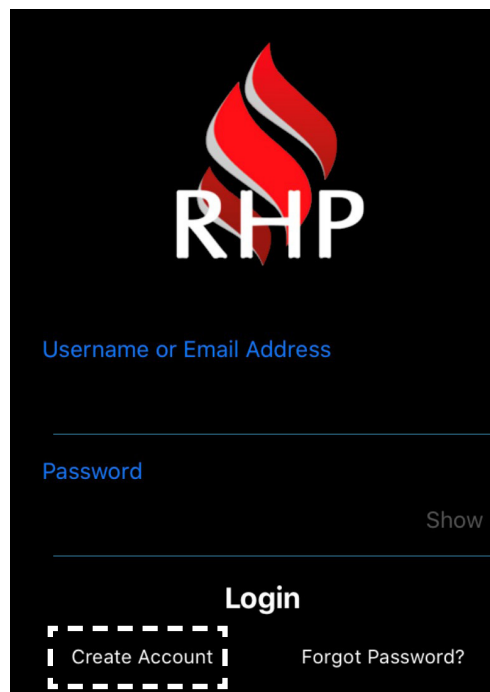

**Fig. 3-2** Select create account / sign up

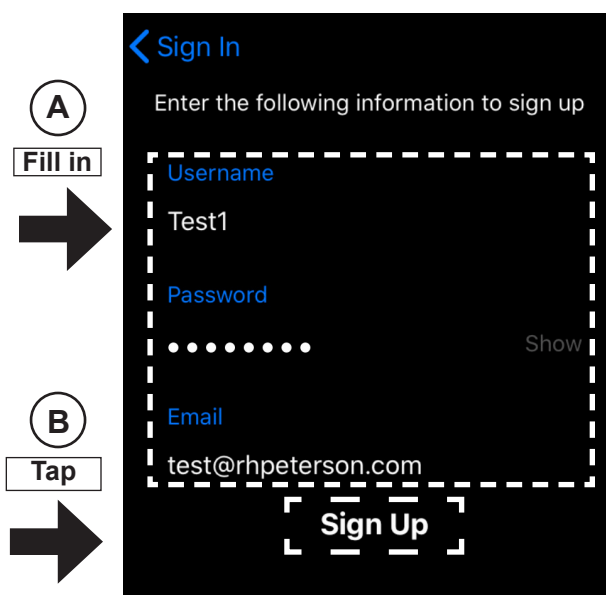

**Fig. 3-3** Fill out screen and sign up

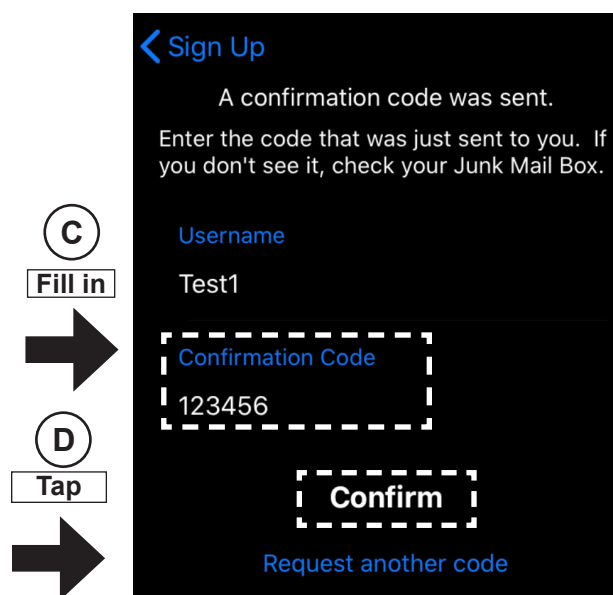

**Fig. 3-4** Confirm sign up

# APP SETUP (Cont.)

## CREATE AN INITIAL ZONE

Once your account is created, proceed to the "Zones" screen, and if needed tap the ⊕ icon to enter the "New Zone" screen as shown below. Fill in the "Enter Location" field. The other fields should auto-fill. Then tap "Save Zone". See Fig. 4-1 and Fig. 4-2 for details.

**Note:** It is recommended you allow RHP Connect to access your location for full functionality of the app.

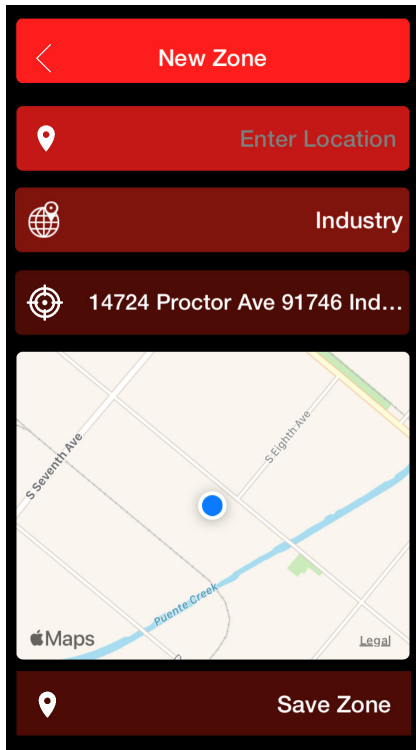

Fig. 4-1 Create zone

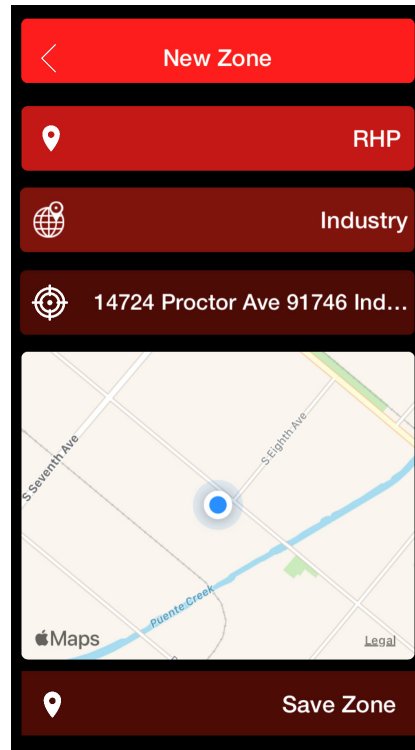

Fig. 4-2 Save zone

## ADD YOUR DEVICE

Push the **POWER** button (control panel - light will illuminate). Proceed into the newly created zone. Follow the prompts to pair your device's bluetooth with the control unit. Once paired, the screen should appear as below (or similar). Fill in the fields as needed. Then tap "Connect". See Fig. 4-3 and Fig. 4-4 for details.



Fig. 4-3 Add your device



Fig. 4-4 Confirm connection

## SETUP COMPLETE

Once you have successfully entered your unit, it will appear as shown below in the "Device" screen. Your remote is now ready. Proceed to the OPERATION sections for details on use.

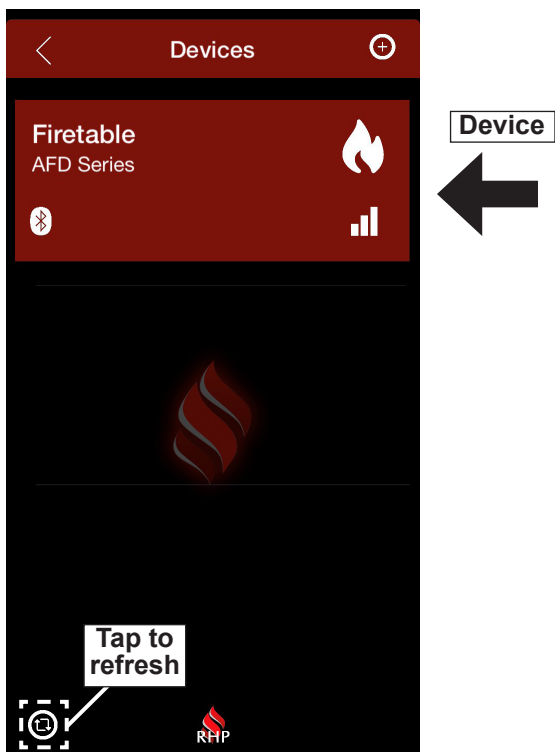

Fig. 5-1 Setup complete

## FORGOT PASSWORD

Select "Forgot password" on the home screen. Then follow the prompts on your screen to update your password. See Fig. 5-2 through Fig. 5-4 for details.

- You will receive an e-mail with a confirmation code; please check junk/spam folders in case the e-mail gets blocked.

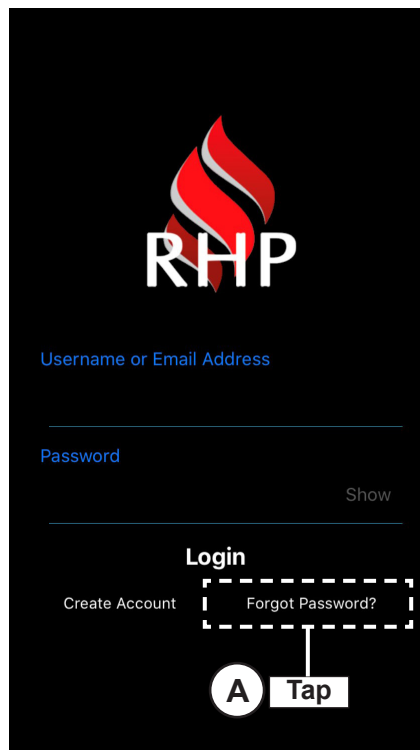

Fig. 5-2 Select forgot password

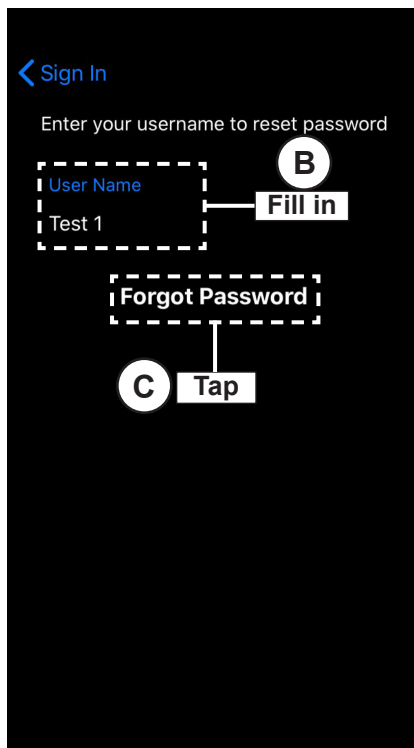

Fig. 5-3 Fill out screen

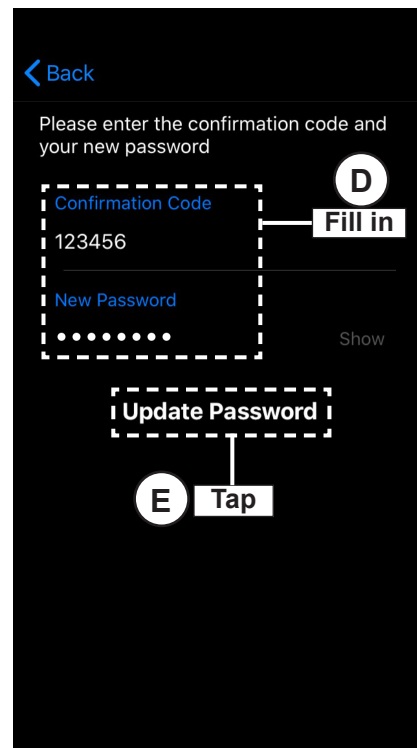

Fig. 5-4 Update password

Please use this page to record any information that you may want to have at hand.

# OPERATION - LIGHTING INSTRUCTIONS

## BEFORE USE

Ensure that the fire unit is installed, the power supply cord is plugged in, and the RHP connect app is downloaded and setup.

**Note:** This is a bluetooth device. It has a max range of operation of 30 feet, and can only be controlled by one phone/tablet at a time.

Ensure that you have read all instructions completely and carefully prior to product use. Refer to them as needed.

## FOR YOUR SAFETY, READ BEFORE LIGHTING

**WARNING: IF YOU DO NOT FOLLOW THESE INSTRUCTIONS EXACTLY, A FIRE OR EXPLOSION MAY RESULT, CAUSING PROPERTY DAMAGE, PERSONAL INJURY, OR LOSS OF LIFE.**

- A. This appliance is equipped with an ignition device that automatically lights the pilot. **DO NOT** attempt to light the pilot by hand.
- B. **BEFORE LIGHTING**, smell all around the unit area for gas. Be sure to smell next to the floor, because some gas is heavier than air and will settle on the floor.
- C. **WHAT TO DO IF YOU SMELL GAS**
  - 1. Shut off the gas to the appliance.
  - 2. Extinguish any open flame.
  - 3. If odor continues, immediately call your gas supplier or the fire department.
- D. Use only your hand to push in the controls. Never use tools. If the control will not push in or move by hand, **DO NOT** try to repair it. Call a qualified professional service technician. Force or attempted repair may result in fire or explosion.

Operation continued on next page

## AVANT UTILISATION

Assurez-vous que l'unité d'incendie est installée, que le cordon d'alimentation est branché et que l'application RHP connect est téléchargée et configurée.

**Note:** Il s'agit d'un appareil Bluetooth. Il a une portée maximale de 30 pieds et ne peut être contrôlé que par un seul téléphone/tablette à la fois.

Assurez-vous d'avoir lu entièrement et attentivement toutes les instructions avant d'utiliser le produit. Consultez-les au besoin.

## POUR VOTRE SÉCURITÉ, À LIRE AVANT L'ÉCLAIRAGE

**WARNING: SI VOUS NE SUIVEZ PAS EXACTEMENT CES INSTRUCTIONS, UN INCENDIE OU UNE EXPLOSION PEUT SE PRODUIRE, CAUSANT DES DOMMAGES MATÉRIELS, DES BLESSURES CORPORELLES OU LA MORT.**

- A. Cet appareil est équipé d'un dispositif d'allumage qui allume automatiquement la veilleuse. **N'essayez PAS** d'allumer la veilleuse à la main.
- B. **AVANT L'ALLUMAGE**, sentez tout autour de la zone de l'unité pour le gaz. Assurez-vous de sentir près du sol, car certains gaz sont plus lourds que l'air et se déposeront sur le sol.
- C. **QUE FAIRE SI VOUS SENTEZ DU GAZ**
  - 1. Coupez l'arrivée de gaz à l'appareil.
  - 2. Éteignez toute flamme nue.
  - 3. Si l'odeur persiste, appelez immédiatement votre fournisseur de gaz ou les pompiers.
- D. Utilisez uniquement votre main pour enfoncer les commandes. N'utilisez jamais d'outils. Si la commande ne s'enfonce pas ou ne se déplace pas à la main, **N'essayez PAS** de la réparer. Appelez un technicien de service professionnel qualifié. La force ou une tentative de réparation peut entraîner un incendie ou une explosion.

Suite de l'opération à la page suivante



## LIGHTING

**CAUTION: DO NOT** attempt to light the pilot by hand.

1. Locate the control panel on the side of the unit (refer to the IDENTIFICATION PARTS LIST if needed), and identify the **AUX CONTROL** and **POWER** buttons (see Fig. 9-1).
2. Push the **POWER** button. The light will illuminate indicating the system is on and ready.
3. From within the app, proceed to the Devices screen and select your unit. The remote screen will appear. See Fig. 9-1.
4. Tap the **ON** icon found on the bottom left of your remote screen (see Fig. 9-1).

The screen will display an orange center flame and moving sparks. The orange center flame and sparks indicate the bluetooth control is on. The **AUX CONTROL** button light will illuminate and the 60 second burner ignition sequence will begin. The burner will light on the high (HI) flame setting.

**WARNING:** The burner ON/OFF status must be verified in person - it is an attended appliance.

**WARNING:** If the pilot fails to light within 15 seconds, or if the burner fails to light within 15 seconds of pilot lighting, tap the OFF icon. Allow five (5) minutes for any gas in the unit to dissipate, then repeat step 3 above. **IF YOU SMELL GAS, SEE STEP (C) AT BEGINNING OF LIGHTING INSTRUCTIONS.**

If the burner fails to light after several tries, push the **POWER** button on the control panel and contact a qualified professional service technician.

## ADJUSTING FLAME HEIGHT

The flame height can be adjusted via the remote app. Tap the **HI (high)** button to increase the flame height. Tap the **LO (low)** button to decrease the flame height. See Fig. 9-1. (LO setting available after 60 seconds.)

## SHUTTING DOWN

**To shut down the burner (system will remain on),** tap the **OFF** icon found on the bottom left of your remote screen. The screen will no longer display the orange center flame and moving sparks. See Fig. 9-1. The **AUX CONTROL** button indicator light will also go off.

**Note:** A 60 second delay exists prior to relighting.

**To shut down the burner and system (total shutdown), or if the remote app is unavailable,** push the **POWER** button on the control panel. See Fig. 9-1. The **POWER** and **AUX CONTROL** button indicator lights will go off. (Fully power off when covering or when not in use.)

## AUX CONTROL

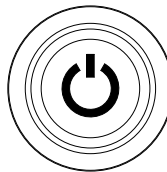
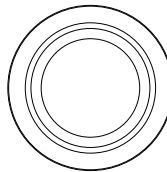

**POWER**

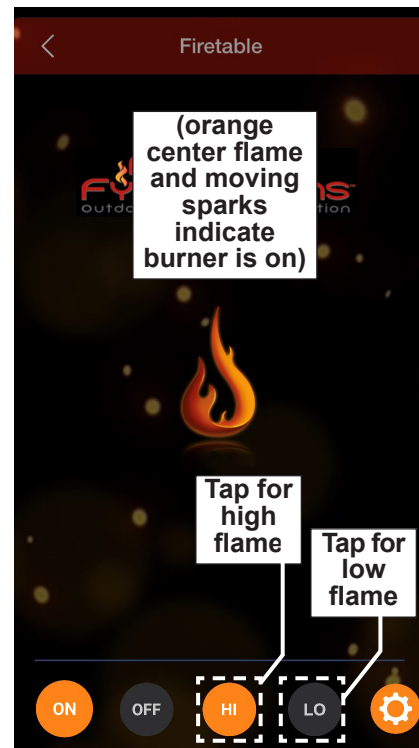

**Fig. 9-1 Remote Operation:**

### Lighting

- push POWER button (system on)
- tap ON icon within remote app (burner on)
- tap H/L icons to adjust flame height

### Shutting Down

- tap OFF icon within remote app (burner off)
- push POWER button (burner and system off)

## ÉCLAIRAGE

**CAUTION:** N'essayez PAS d'allumer la veilleuse à la main.

1. Localisez le panneau de commande sur le côté de l'appareil (reportez-vous à la LISTE DES PIÈCES D'IDENTIFICATION si nécessaire), et identifiez les boutons **AUX CONTROL** et **POWER** (voir Fig. 10-1).
2. Appuyez le bouton **POWER**. Le voyant s'allumera pour indiquer que le système est activé et prêt.
3. Depuis l'application, accédez à l'écran Appareils et sélectionnez votre appareil. L'écran à distance apparaîtra. Voir Fig. 10-1.
4. Appuyez sur l'icône **ON** située en bas à gauche de l'écran de votre télécommande (voir Fig. 10-1).

L'écran affichera une flamme centrale orange et des étincelles en mouvement. La flamme centrale orange et la flamme des étincelles indiquent que la commande Bluetooth est activée. Le voyant du bouton **AUX CONTROL** s'allumera et la 60 secondes séquence d'allumage du brûleur commencera. Le brûleur s'allumera sur le réglage de flamme élevée (HI).

**AVERTISSEMENT:** L'état ON/OFF du brûleur doit être vérifié en personne - il s'agit d'un appareil surveillé.

**AVERTISSEMENT:** Si la veilleuse ne s'allume pas dans les 15 secondes, ou si le brûleur ne s'allume pas dans les 15 secondes suivant l'allumage de la veilleuse, appuyez sur l'icône **OFF**. Attendez cinq (5) minutes pour que tout gaz dans l'unité se dissipe, puis répétez l'étape 3 ci-dessus. **SI VOUS SENTEZ DU GAZ, VOIR L'ÉTAPE (C) AU DÉBUT DES INSTRUCTIONS D'ALLUMAGE.**

Si le brûleur ne s'allume pas après plusieurs essais, appuyez sur le bouton **POWER** du panneau de commande et contactez un technicien de service professionnel qualifié.

## RÉGLAGE DE LA HAUTEUR DE LA FLAMME

La hauteur de la flamme peut être ajustée via l'application à distance. Appuyez sur le bouton **H (élevé)** pour augmenter la hauteur de la flamme. Appuyez sur le bouton **L (bas)** pour diminuer la hauteur de la flamme. Voir Fig. 10-1. (Réglage LO disponible après 60 secondes.)

## ÉTEINDRE

**Pour éteindre le graveur (le système restera allumé),** appuyez sur l'icône **OFF** située en bas à gauche de l'écran de votre télécommande. L'écran n'affichera plus la flamme centrale orange et les étincelles en mouvement. Voir Fig. 10-1. Le voyant du bouton **AUX CONTROL** s'éteindra également.

**Note:** Un délai de 60 secondes existe avant le rallumage.

**Pour éteindre le brûleur et le système (arrêt total), ou si l'application à distance n'est pas disponible,** appuyez sur le bouton **POWER** du panneau de commande. Voir Fig. 10-1. Les voyants des boutons **POWER** et **AUX CONTROL** s'éteignent. (Éteignez complètement lorsque vous couvrez ou lorsque vous ne l'utilisez pas.)

## AUX CONTROL

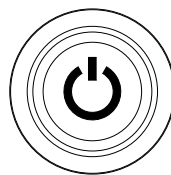
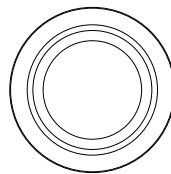

**POWER**

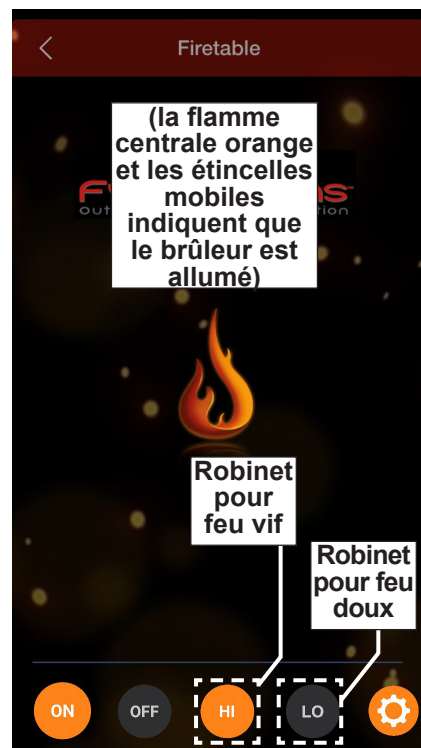
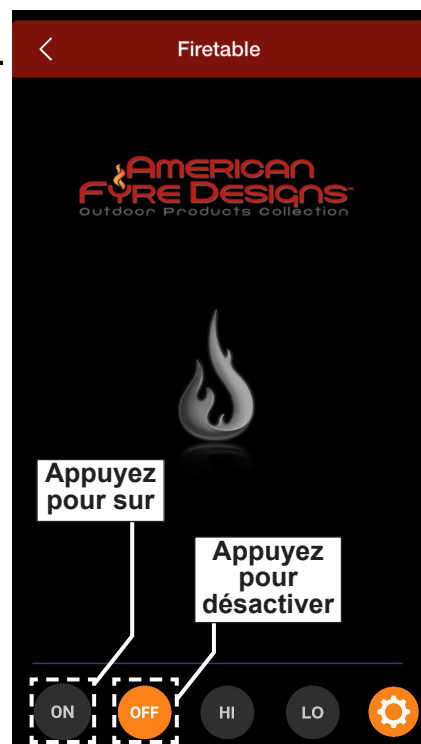

**Fig. 10-1** Opération à distance:

### Éclairage

- appuyez sur le bouton **POWER** (système allumé)
- appuyez sur l'icône **ON** dans l'application distante (brûleur activé)
- appuyez sur les icônes **H/L** pour régler la hauteur de la flamme

### Éteindre

- appuyez sur l'icône **OFF** dans l'application distante (brûleur éteint)
- appuyez sur le bouton **POWER** (brûleur et système éteints)

**SETTINGS**

The remote screen displays a settings icon on the bottom right of the screen. Tap the icon to enter and view the settings. Adjust as needed. Tap the confirm icon to exit the screen. See Fig. 11-1 and Fig. 11-2.

**Note:** Turning the Notifications to "On" will enable a 2 hour reminder on your phone. This features informs you that the burner has been on for 2 hours, via a pop up notification. To disable, simply turn off the Notifications option. See Fig. 11-2.

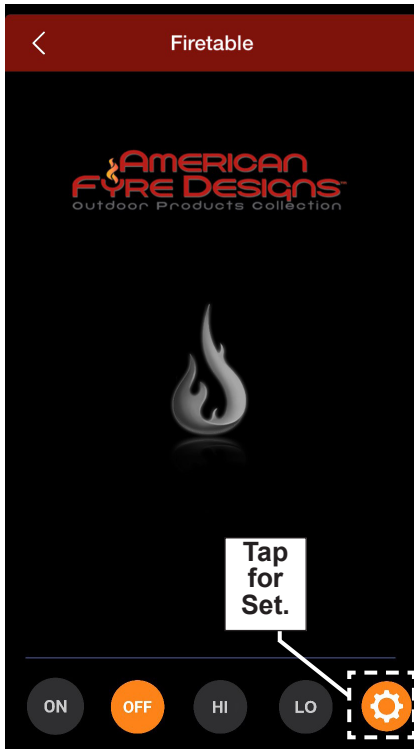

Fig. 11-1 Remote screen detail

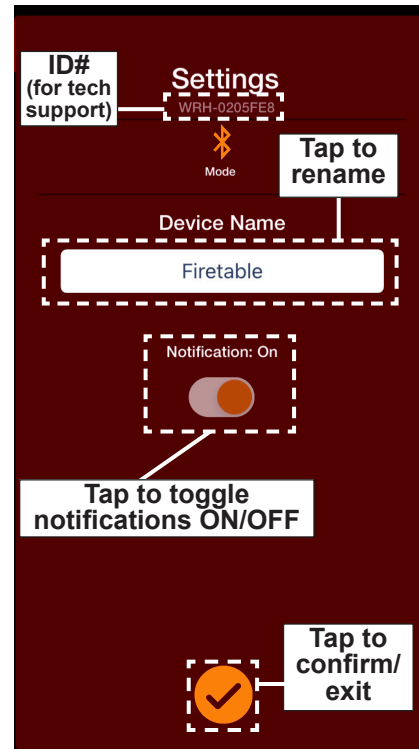

Fig. 11-2 Settings screen

## ADDING, EDITING, DELETING A NEW ZONE OR DEVICE

- To add an additional zone or device, tap the ⊕ icon found on the top right of your screen (see Fig. 12-1 or Fig. 12-2).
- To delete a zone or device, slide your finger across the desired unit, and tap "Delete" (see Fig. 12-1 or Fig. 12-2).
- To edit an existing zone, slide your finger across the desired zone, and tap "Edit" (see Fig. 12-1).

## LOGGING OUT

To log out, simply click on the logout icon and then tap yes (see Fig. 12-3).

**Note:** To prevent unwanted use, it is recommended to log out after device is turned off.

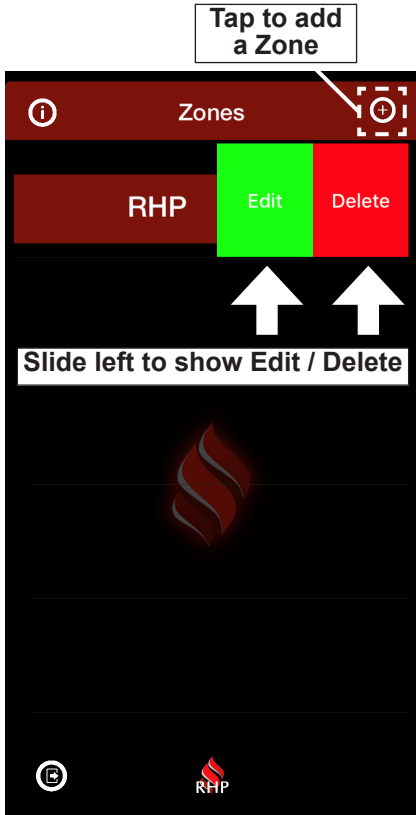

Fig. 12-1 Add/Edit/Delete Zone

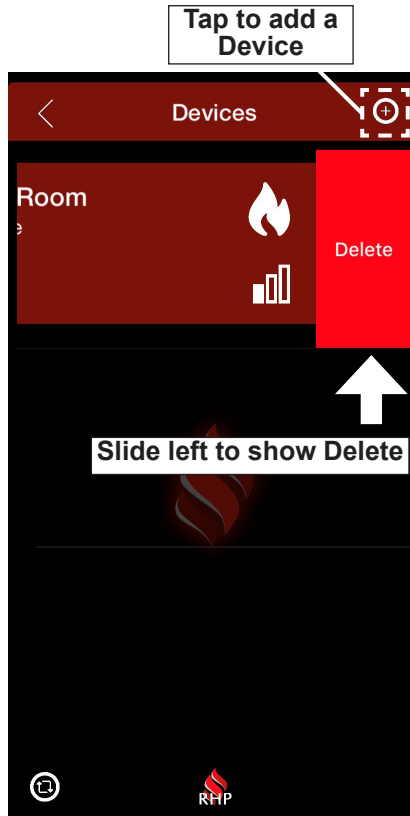

Fig. 12-2 Add/Delete Device

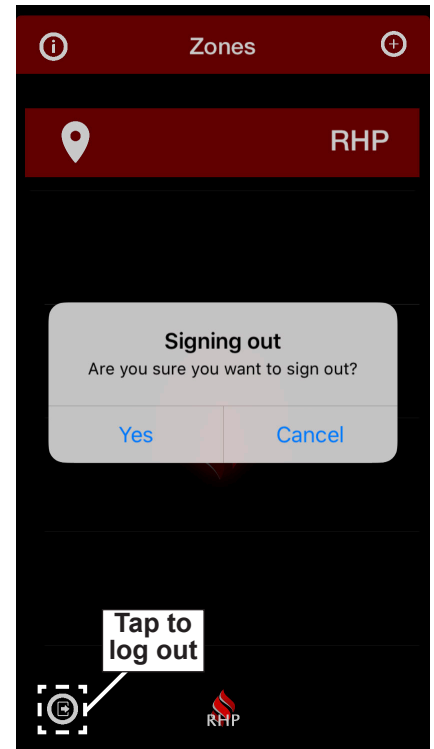

Fig. 12-3 Logging out

# TROUBLESHOOTING

## INSTALLATION OR APP USE ISSUES

If you have trouble with the bluetooth control installation or app use, please reference this list below to identify the problem.

<b>BURNER SYSTEM WILL NOT TURN ON</b>	
<b>Root Cause</b>	<b>Corrective Action</b>
Power button not on	Ensure power button (on control panel) is on (and light is illuminated)
Phone out of range of bluetooth control	Ensure phone is within 30 feet or less of the control.
Appliance not receiving power or fuse is tripped	Refer to main manual supplied with the AFD fire unit.
Electronic device not paired with bluetooth control	Pair device (refer to <u>ADD YOUR DEVICE</u> section for details)
Faulty bluetooth control	Check/replace bluetooth control.

<b>BLUETOOTH CONTROL DOES NOT RESPOND TO ELECTRONIC DEVICE</b>	
<b>Root Cause</b>	<b>Corrective Action</b>
Electronic device not paired with bluetooth control	Pair device.
App update needed	Check for App updates.
Loose wires	Check all wires are connected properly.

<b>BURNER SYSTEM WILL NOT TURN OFF</b>	
<b>Root Cause</b>	<b>Corrective Action</b>
Phone out of range of bluetooth control	Ensure phone is within 30 feet or less of the control.
Bluetooth disconnected	Reconnect bluetooth.
Burner was not turned on with the Remote App	If you turned the burner on using the AUX button, turn off using the AUX button (on control panel).
Unable to locate or use the Phone App	If you are unable to turn off the burner using the remote app, turn off by pushing the POWER button on the control panel.
Faulty bluetooth control	Check/replace bluetooth control.

## TECHNICAL APP ISSUES

If you need assistance on a technical issue related to the app (log in, connectivity, etc.), please e-mail the app support department [support@app-assist.com](mailto:support@app-assist.com).

## BURNER SYSTEM ISSUES

If you have trouble with the installation or operation of the burner system, see the TROUBLESHOOTING section of the manual included with your burner.

If the information on this page does not resolve your issue, please contact your local dealer, e-mail our general support department: [support@rhpeter.com](mailto:support@rhpeter.com), or visit our web site at [www.rhpeter.com](http://www.rhpeter.com).

Please use this page to record any information that you may want to have at hand.